

DOWNLOADING NEW FIRMWARE TO THE KEGS5000

The KEGS5000 can have new firmware downloaded through the RS-232 port. This is done through a simple windows program called Ultrak Code Server.

To download the latest version of the Code Server visit the download section on the Ultrak website (www.ultrak.com) select Software Downloads on the left or go directly to http://www.ultrak.com/Download_Registrations/Software_Downloads/Index.htm . Click on KEGS5000 and follow the instructions to download the Ultrak Code Server.

To download the latest version of the KEGS5000 firmware, Right click the link and save this to your PC.

NOTE: The Standalone version is used in the KEGS5000 to directly control KD6 domes and Ultrak multiplexers.

The Slave version is used when the KEGS5000 is to control a KSX3208L matrix or a MXSYS04E controller. It also has a mode to work with the Maxpro MAX1000

1. Connect the KEGS5000 to COM1 or COM2 of your PC.
(Refer to the diagrams below for correct download cable connections.)

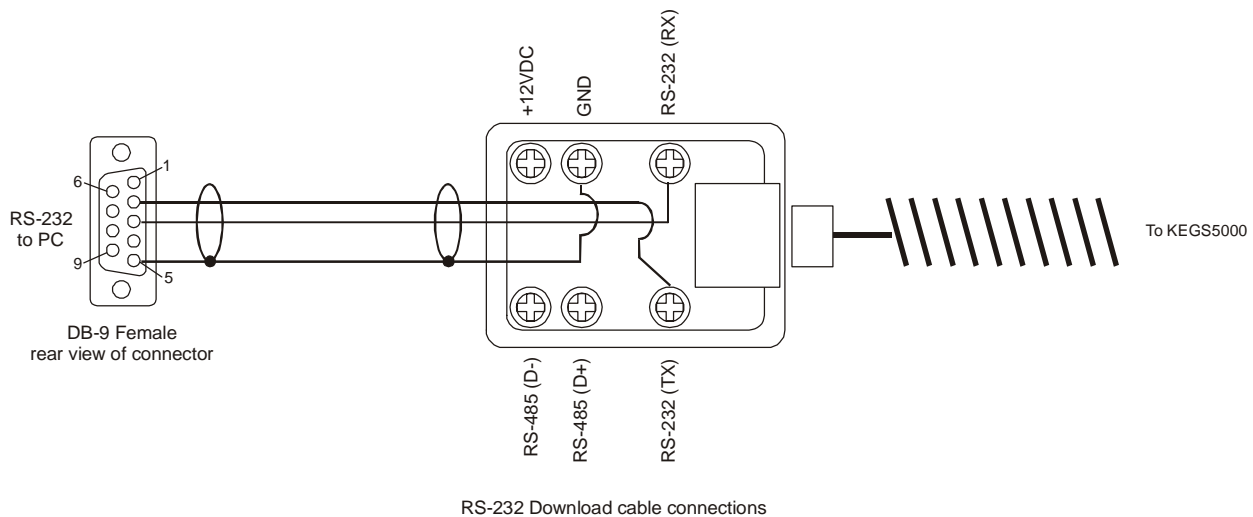

2. Disconnect power from the KEGS5000. Reconnect the power and, before the timer reaches zero, press **1** on the controller. This will put the controller into the download mode.
3. Enter the **Configuration** password. **1994** for Boot loader 1.61 and earlier and **9441** for Boot loader version 1.63 and later.
4. Press the **←** or **→** arrow keys until the LCD display shows **Download Firmware**.

5.4 DOWNLOADING NEW FIRMWARE TO THE KEGS5000, CONTINUED

5. Press . The controller will clear the memory and, when ready to download, will display the message "**Begin Download.**" The KEGS5000 is now waiting for data from the PC.
6. From the START bar on your PC, select Programs→Ultrak→Ultrak Code Server. The following window appears.

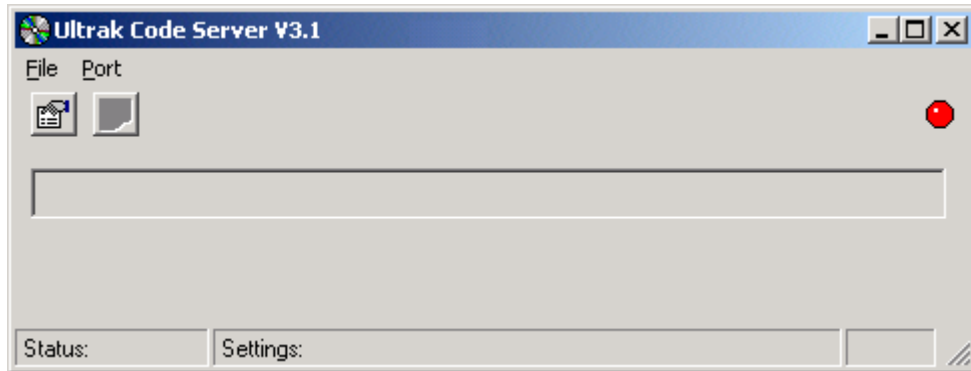



Figure 1: Ultrak Code Server window

7. The Port Properties icon  allows you to select which serial port to use. Clicking on this opens the CommPort Properties window:

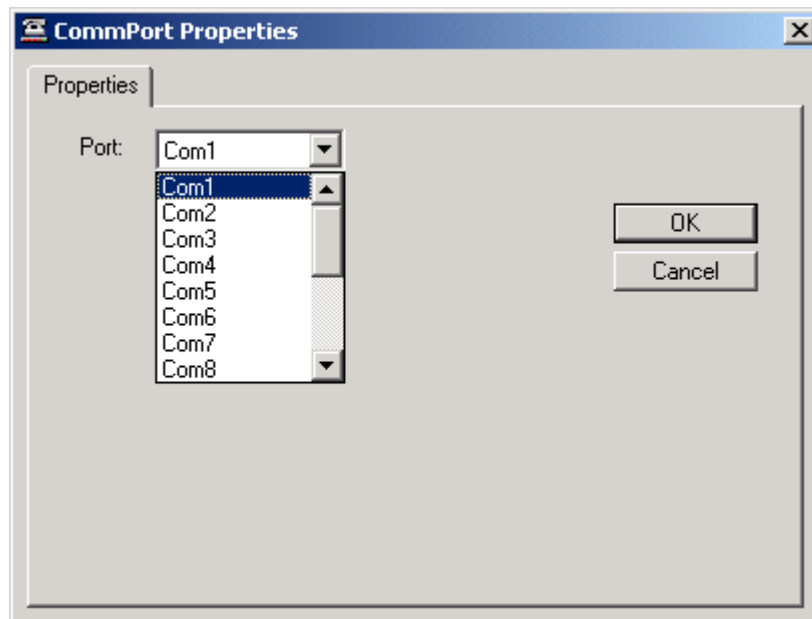

Figure 2: CommPort Properties window

Select the serial port the download adapter is connected to and click OK.

5.4 DOWNLOADING NEW FIRMWARE TO THE KEGS5000, CONTINUED

- Click on the red dot to enable the port.

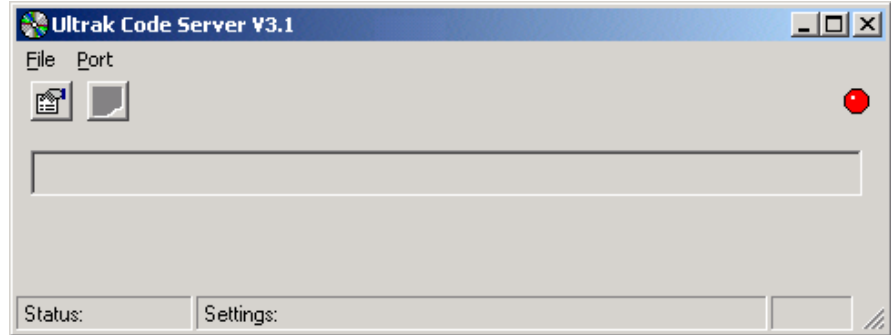



Figure 3: Enabling the CommPort

If the port is unavailable, you will get an “Invalid port number” error message.

This is because the port is being used by another device, usually the mouse or a modem. Click on the properties icon and select a different port.



Figure 4: Invalid Port Error

- If the port is available the red dot changes to green and the Transmit Hex file icon  becomes visible.

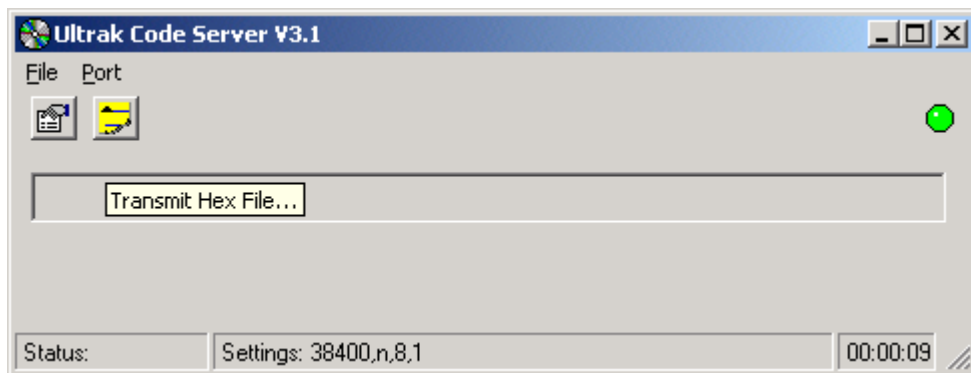

Figure 5: Transmit Hex File

5.4 DOWNLOADING NEW FIRMWARE TO THE KEGS5000, CONTINUED

10. Click on the Transmit Hex File icon  to bring up the Send Hex File window.

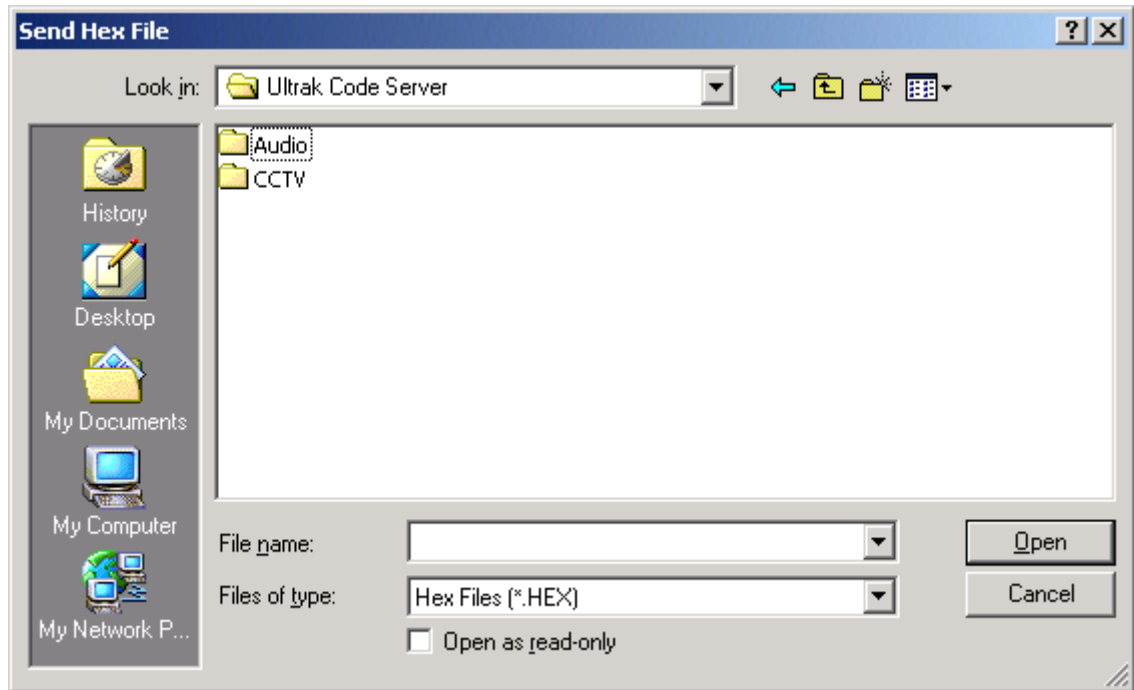

Figure 6: Send Hex File window

11. Double click the CCTV folder and then the KEGS5000 folder.

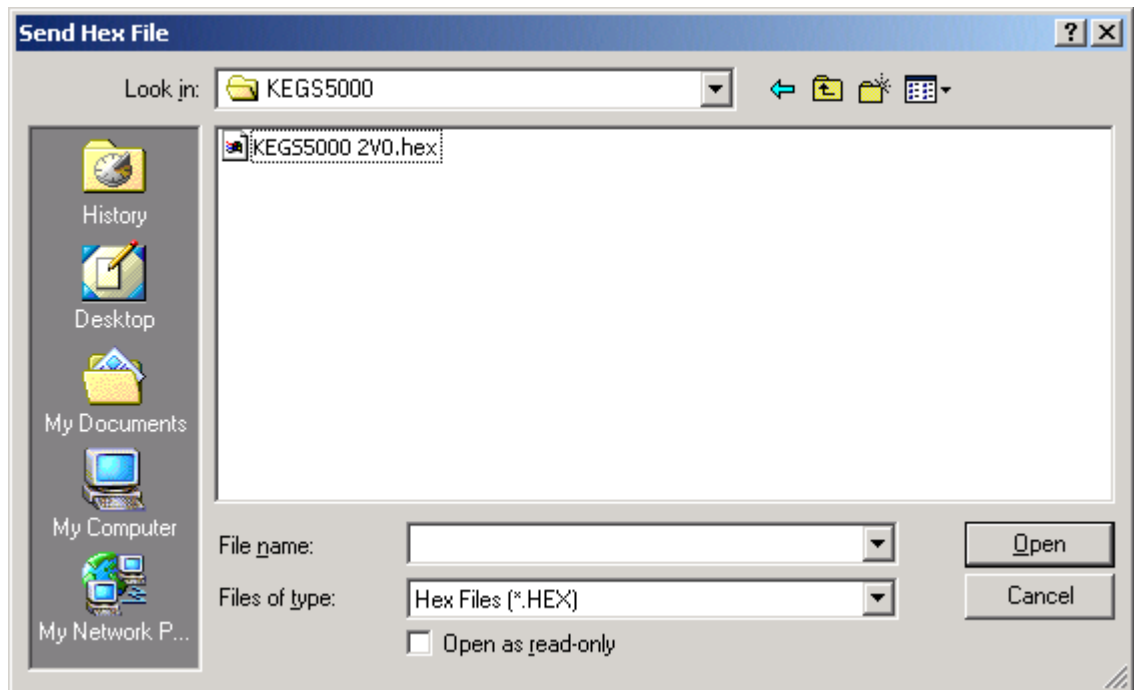

Figure 7: Selecting the Hex File to Send

5.4 DOWNLOADING NEW FIRMWARE TO THE KEGS5000, CONTINUED

12. Select the latest version (in this example, KEGS5000 2V0.hex) and click OPEN. The Sending Hex File window displays, indicating the file being transmitted and the progress of the download. “**Download Busy**” appears on the KEGS5000 LCD.

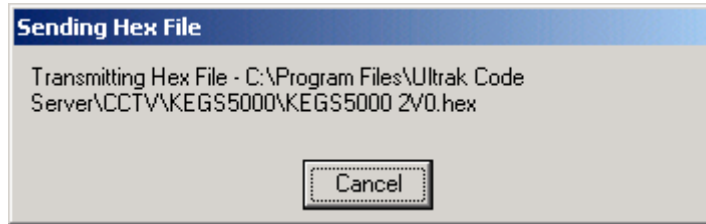

Figure 8: Sending Hex File status window

13. When the download is complete, a **Transfer Complete** window will display and the KEGS5000 will restart with the new version of the software.

Click OK to close the Ultrak Code Server.

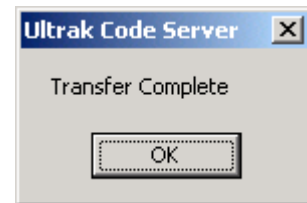

Figure 9: Transfer Complete